



MarelliMotori
Inspired solutions



View product on website

GENERATORE SINCRONO TRIFASE
THREE - PHASE SYNCHRONOUS
GENERATOR

MXB 160 SA4

Project: _____

Reference: _____

CLASSE DI SOVRATEMPERATURA - TEMPERATURE RISE CLASS	H		
CLASSE DI ISOLAMENTO - INSULATION CLASS	H		
PASSO DI AVVOLGIMENTO - WINDING PITCH	2/3		
FORMA COSTRUTTIVA - MOUNTING	B2		
TEMPERATURA AMBIENTE (°C) - AMBIENT TEMPERATURE (°C)	40		
ALTITUDINE (m s.l.m) - ALTITUDE (m a.s.l.)	1000		
SISTEMA DI RAFFREDDAMENTO - COOLING SYSTEM / PROTEZIONE - PROTECTION DEGREE	IC01 / IP23		
FATTORE DI POTENZA - POWER FACTOR	0.80		
NUMERO DI POLI - NUMBER OF POLES	4		
VELOCITA' NOMINALE (r.p.m.) - RATED SPEED (r.p.m.)	1500		
SOVRAVELOCITA' (r.p.m.) - OVERSPEED (r.p.m.)	2250		
NUMERO DI TERMINALI - NUMBER OF TERMINALS	12		
PESO (kg) - WEIGHT (kg)	Approx. 82		
MOMENTO D'INERZIA (J) (kg*m ²) - INERTIA (J) (kg*m ²)	Approx. 0.13		
TEMPERATURA ACQUA RAFFREDDAMENTO (°C) - COOLING WATER TEMPERATURE (°C)			
PORTATA D'ACQUA (m ³ /h) - WATER FLOW RATE (m ³ /h)			
CADUTA DI PRESSIONE (kPa) - PRESSURE DROP (kPa)			
AUMENTO TEMPERATURA ACQUA (°C) - WATER TEMPERATURE INCREASE (°C)			
TA DI CENTRO STELLA - NEUTRAL POINT CURRENT TRANSFORMER			
CUSCINETTI - BEARINGS			
FREQUENZA - FREQUENCY	Hz	50	
TENSIONE - VOLTAGE	V	400	
CORRENTE NOMINALE - RATED CURRENT	A	14.4	
POTENZA - RATING	kVA	10	
RENDIMENTO - EFFICIENCY - (%)	4/4	85.6	
P.F.= 1.0	3/4	87.0	
	2/4	87.5	
RENDIMENTO - EFFICIENCY - (%)	4/4	81.2	
P.F.= 0.8	3/4	82.9	
	2/4	83.7	
Rapporto di corto circuito - short circuit ratio	SCR	0.63	
reattanza - reactance (%)	sincrona diretta - synchronous direct axis	X _d uns	231
	sincrona in quadratura - synchr. quadrature axis	X _q uns	129
	transitoria diretta - transient direct axis	X' _d sat	21.4
	transitoria in quadratura - transient quadrature axis	X' _q uns	129
	subtransitoria diretta - subtransient direct axis	X'' _d sat	9.4
	subtransitoria in quad. - subtransient quadr. axis	X'' _q sat	12.8
	di sequenza negativa - negative sequence	X ₂ sat	11.1
	di sequenza zero - zero sequence	X ₀ sat	1.9
costanti di tempo - time constants (s)	a vuoto - open circuit	T' _{do}	0.350
	transitoria - transient	T' _d	0.030
	subtransitoria - subtransient	T'' _d	0.010
	unidirezionale - armature	T _a	0.000
Coppia di corto circuito bifase - Phase to Phase short circuit torque	kN*m	1.0	
Coppia di corto circuito trifase - Three phase short circuit torque	kN*m	0.7	



MarelliMotori
Inspired solutions

MXB 160 SA4

PRELIMINARY

GENERATORE SINCRONO TRIFASE
THREE - PHASE SYNCHRONOUS
GENERATOR

Project: _____

Reference: _____

CURVA DI RENDIMENTO - EFFICIENCY CURVE

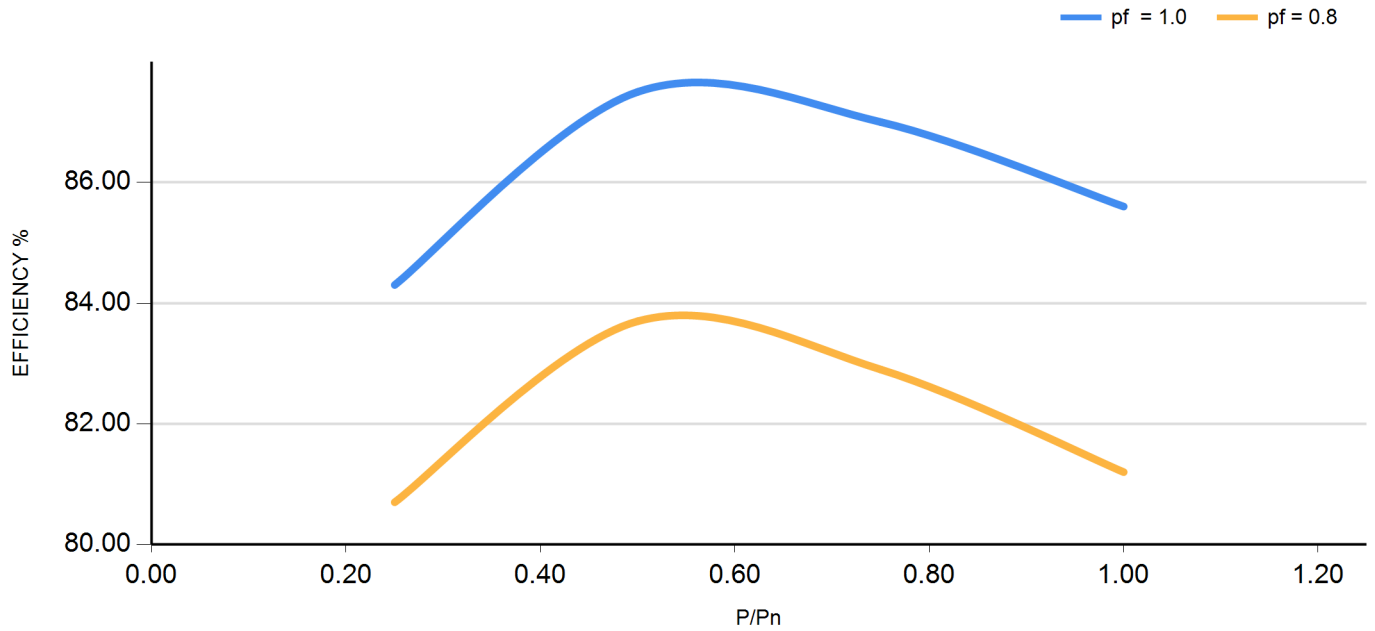

CADUTA DI TENSIONE - VOLTAGE DIP

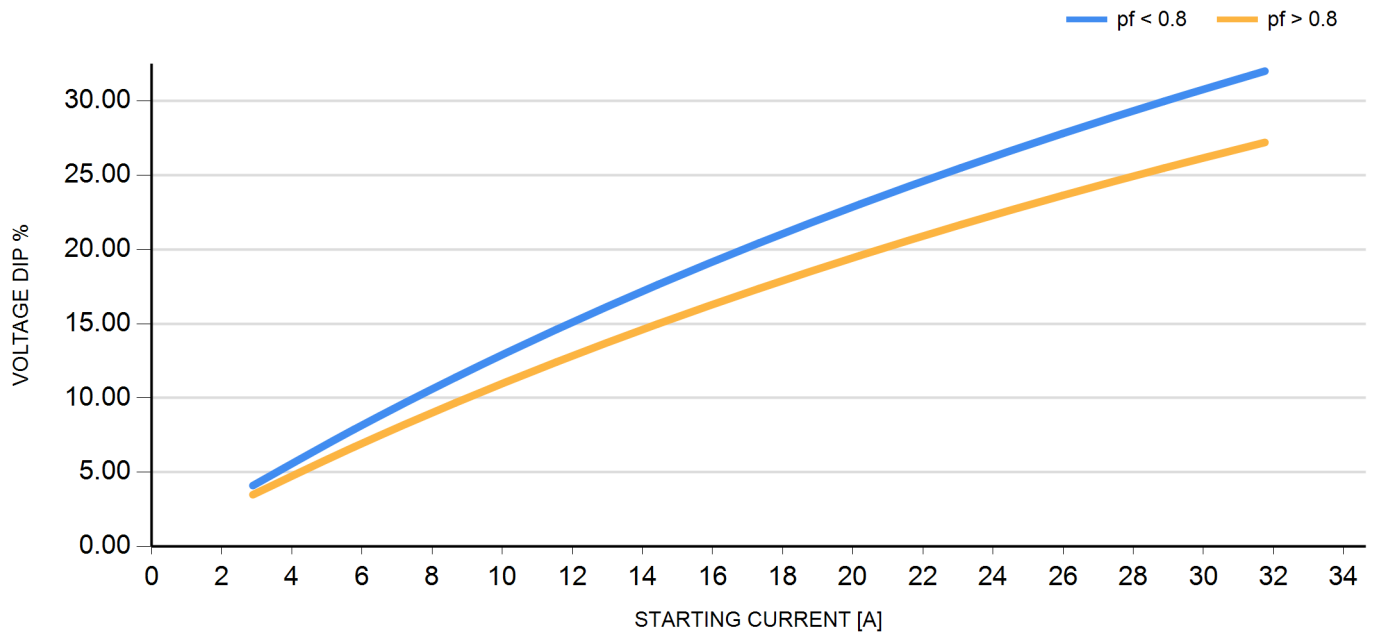



MarelliMotori
Inspired solutions

MXB 160 SA4

PRELIMINARY

GENERATORE SINCRONO TRIFASE
THREE - PHASE SYNCHRONOUS
GENERATOR

Project: _____

Reference: _____

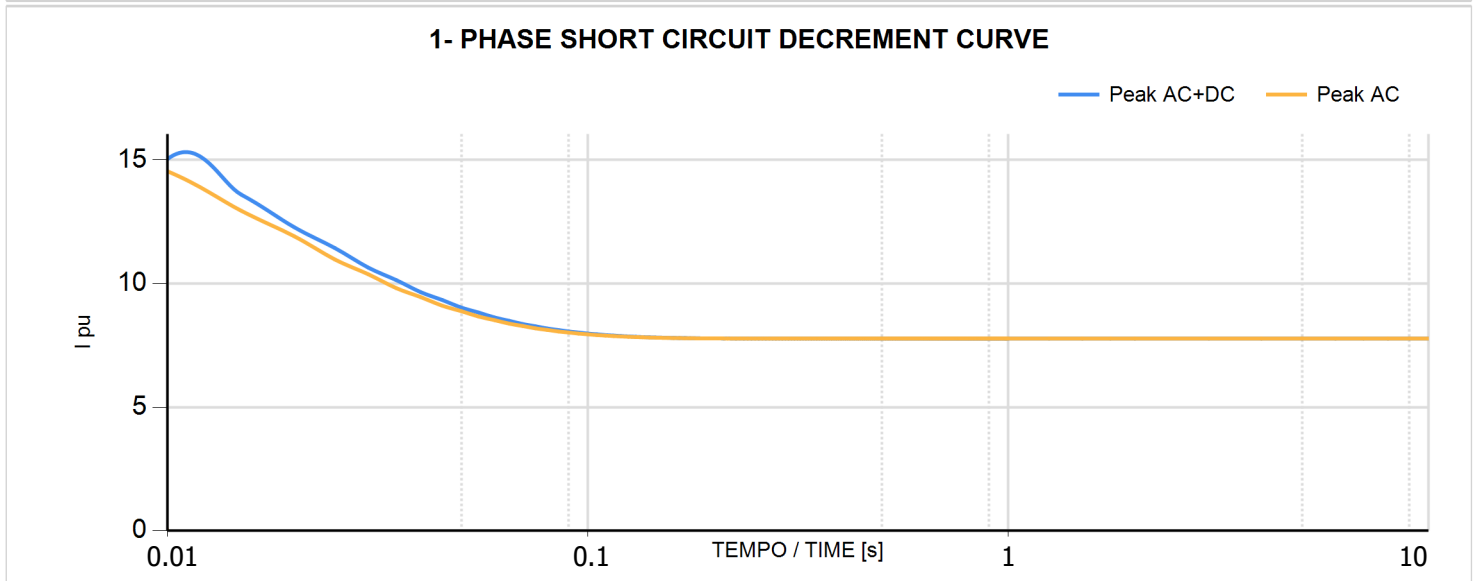
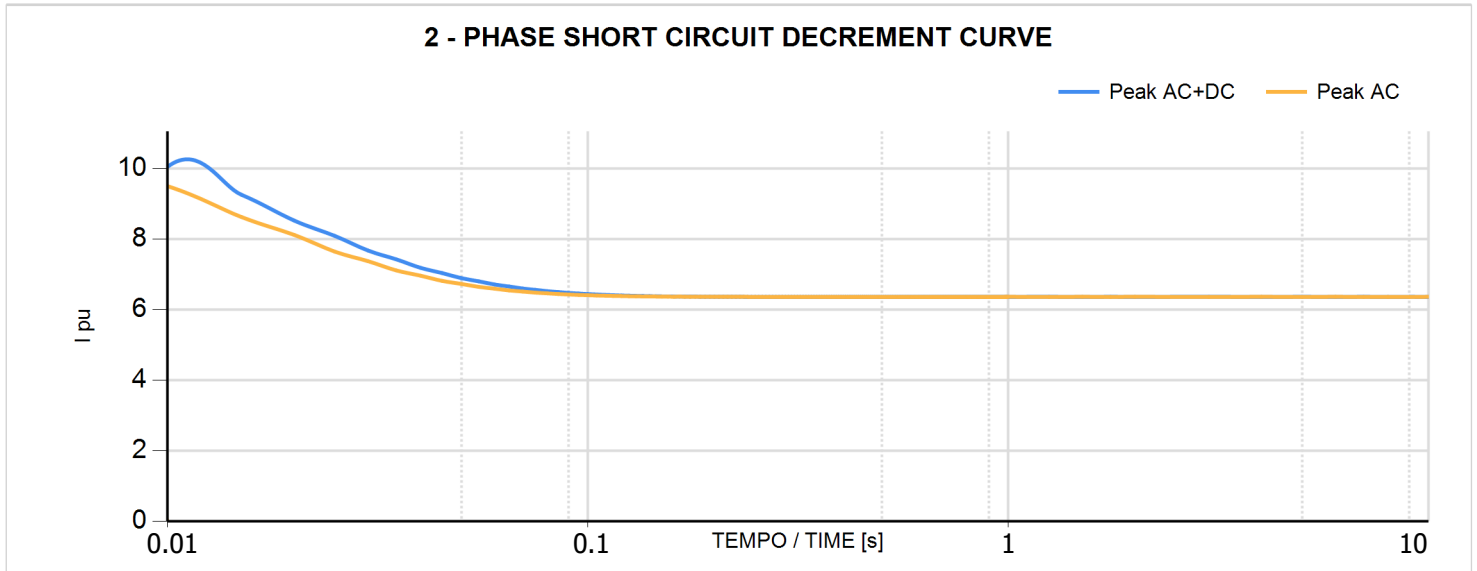
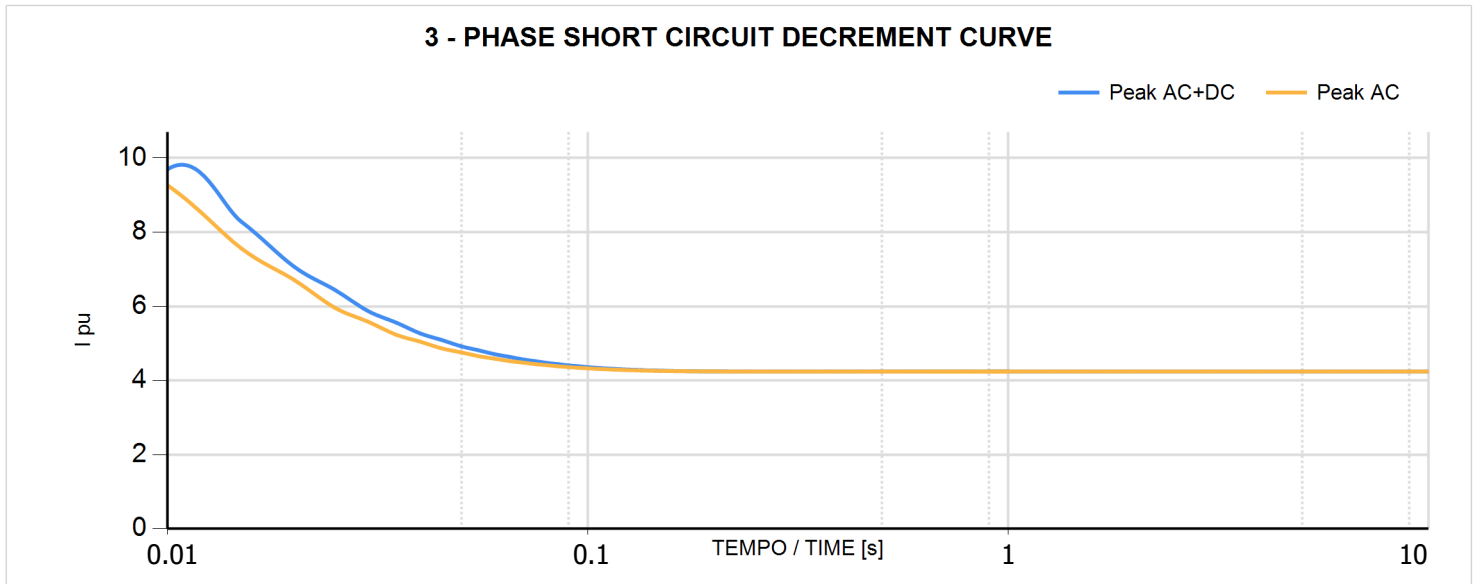



MarelliMotori
Inspired solutions

MXB 160 SA4

PRELIMINARY

GENERATORE SINCRONO TRIFASE
THREE - PHASE SYNCHRONOUS
GENERATOR

Project: _____

Reference: _____

CURVA DI LIMITE TERMICO - THERMAL DAMAGE CURVE

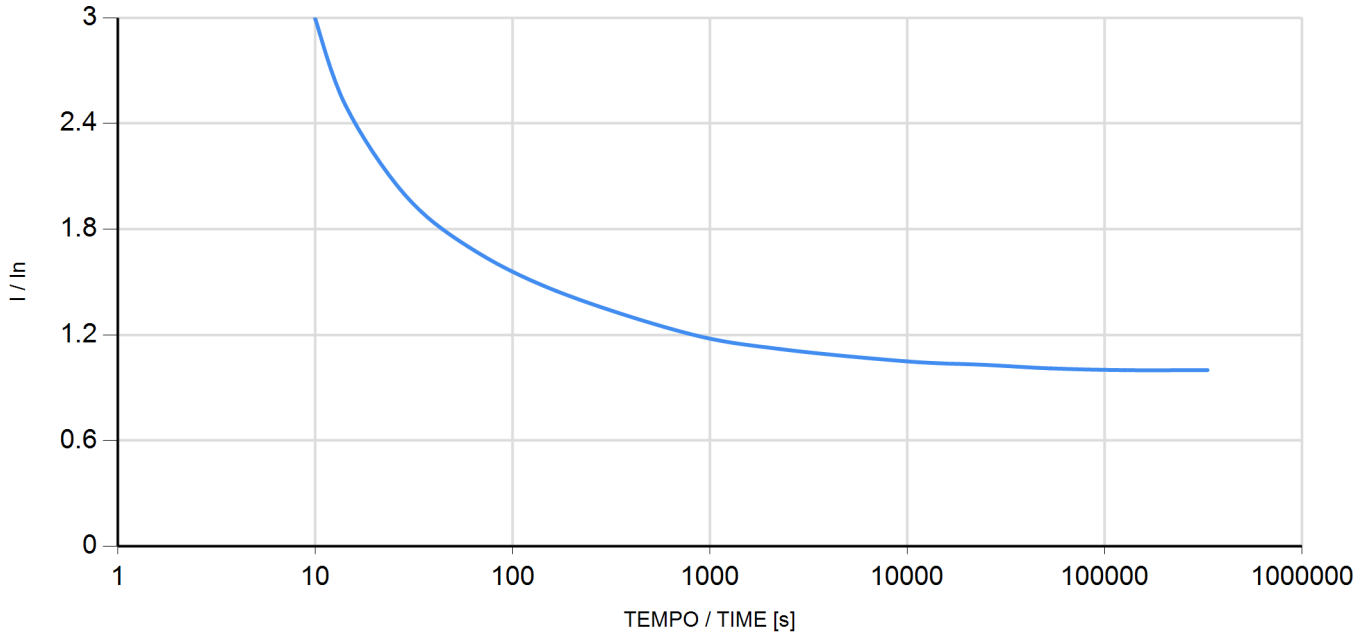

CORRENTE SEQUENZA INVERSA - NEGATIVE SEQUENCE CURRENT

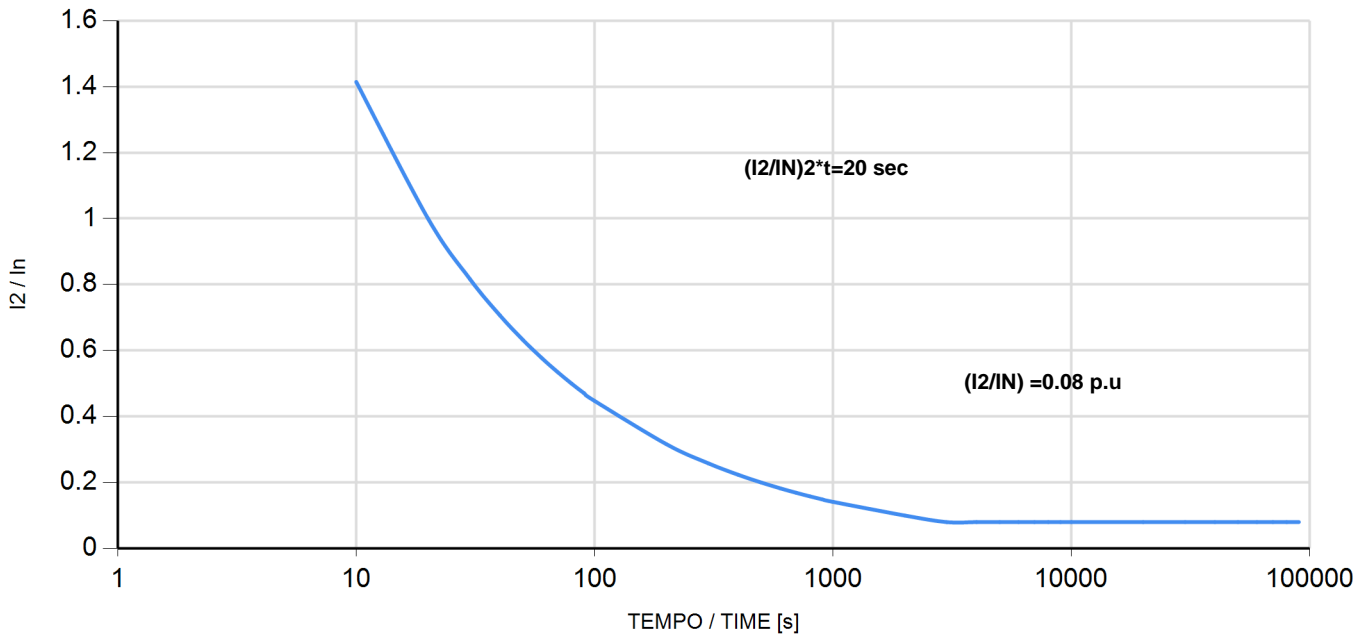



MarelliMotori
Inspired solutions

MXB 160 SA4

PRELIMINARY

GENERATORE SINCRONO TRIFASE
THREE - PHASE SYNCHRONOUS
GENERATOR

Project: _____

Reference: _____

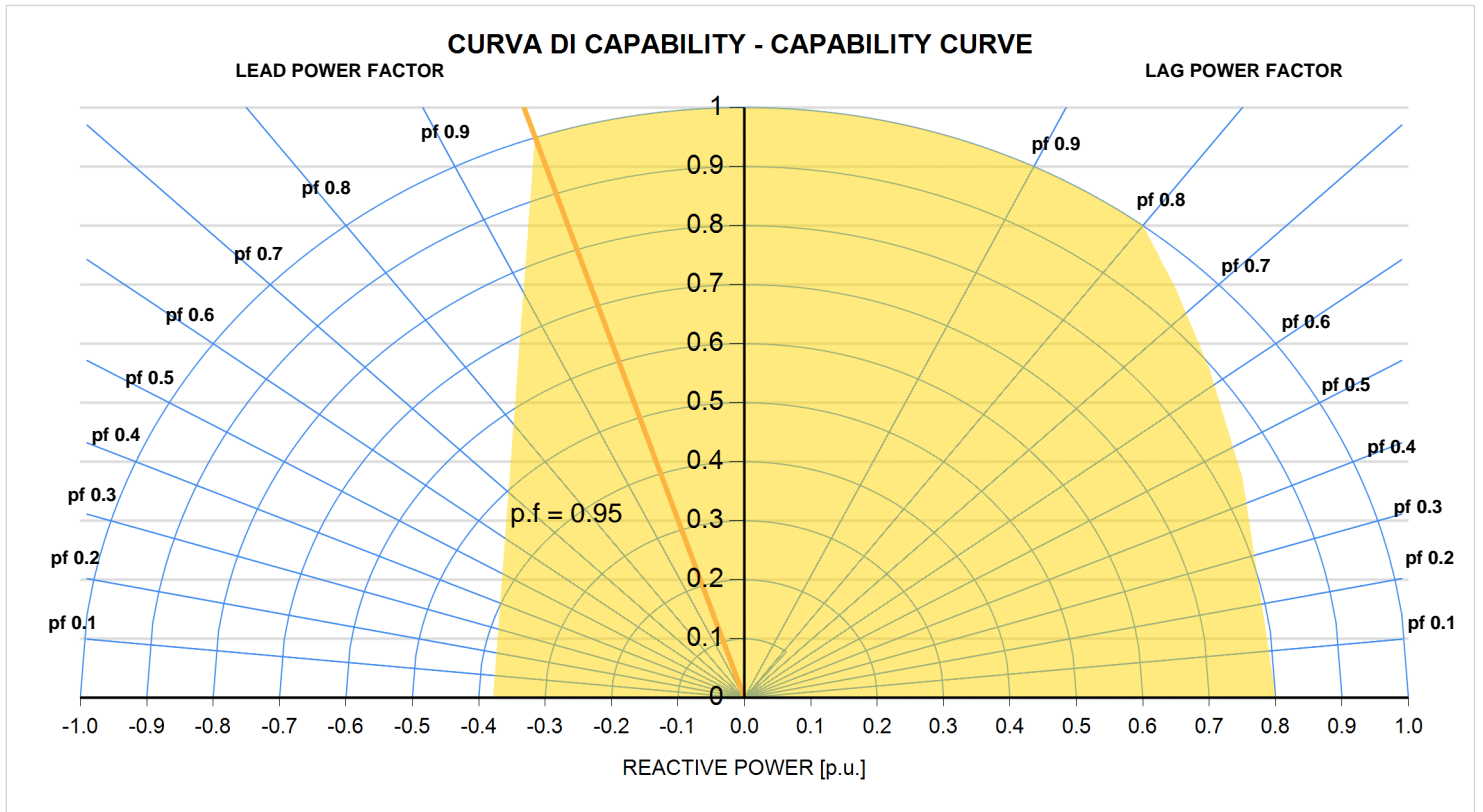

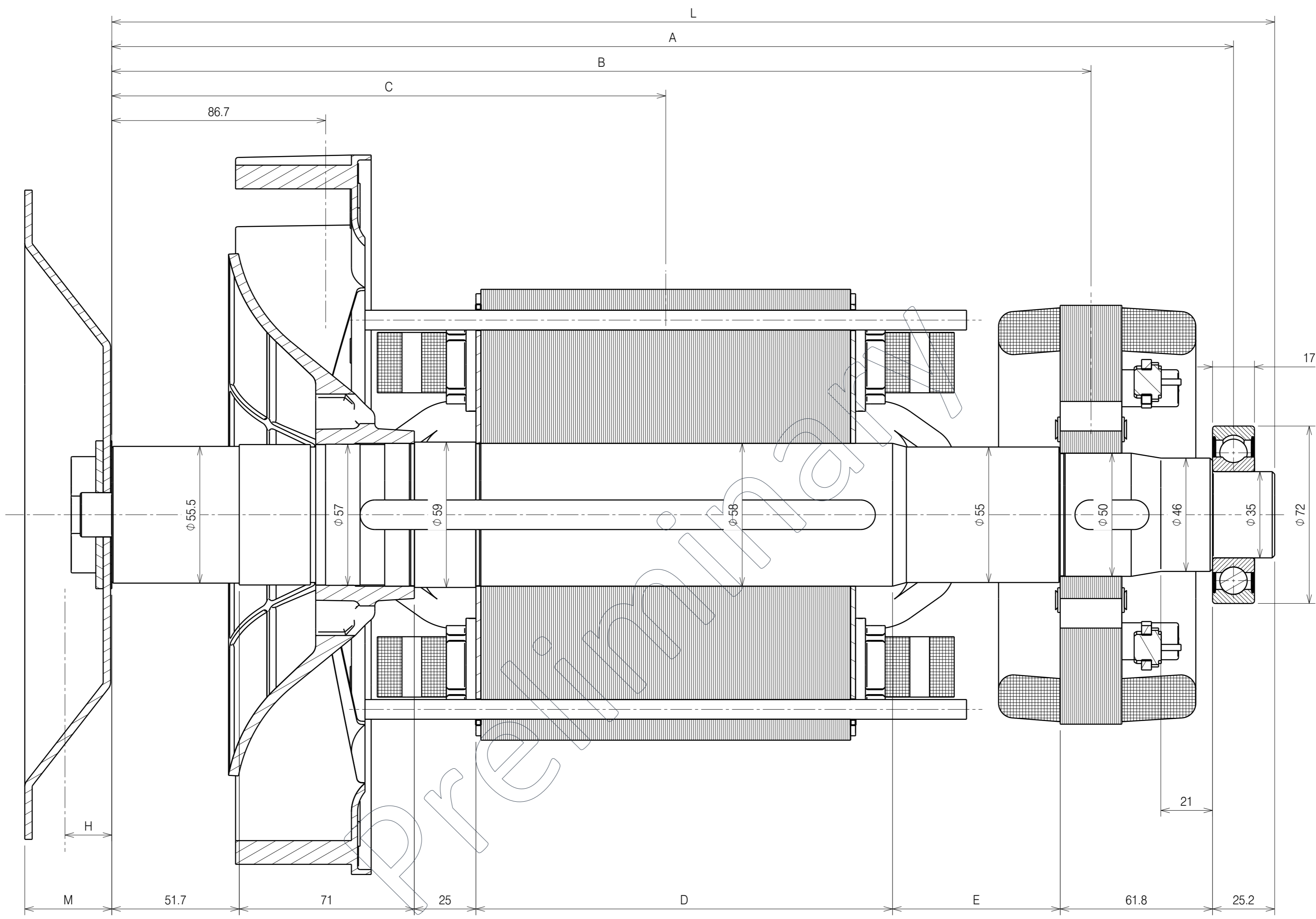

COUPLING	H	M	N	P	m [kg]	J [kgm ²]
SAE 6 1/2	1.4	122.7	3.5	89.2	0.9	0.005
SAE 7 1/2	1.4	122.7	3.5	89.2	1.1	0.008
SAE 8	16.8	122.7	35.3	121	1.4	0.012
SAE 10	3.4	122.7	27.1	112.8	2.2	0.022
SAE 11 1/2	5.5	122.7	12.9	98.6	2.3	0.035

SIZE	DIMENSIONS mm						FAN		SHAFT		MAIN CORE		EXCITER CORE		TOTAL	
	A	B	C	D	E	L	m [kg]	J [kgm ²]	m [kg]	J [kgm ²]	m [kg]	J [kgm ²]	m [kg]	J [kgm ²]	m [kg]	J [kgm ²]
SA	415	357,2	194,7	119	78	431,7	0,39	0,004	7,8	0,003	16,9	0,074	4,7	0,038	31,2	0,131
SB			202,2								19,1	0,083			33,4	0,14
MA	440	382,2	209,7	149	73	456,7			8,4	0,003	21,3	0,093			36	0,15
MB			217,2								23,5	0,103			38,2	0,16

A	UPDATED DIMENSIONS TABLE (COORD. H1)	D.Pegoraro	I.Graizzaro	F.Savegnago	14/12/2017
=	FIRST ISSUE	P.Innocente	C.Vanzin	F.Savegnago	20/04/2017
REV	DESCRIPTION	PREP'D	CHK'D	APPR'D	DATE
ECO:	HEAT TREATMENT:	MAT:		IND. ENG. CHK'D:	
JOB:	SURFACE TREATMENT:	RAW MAT.CODE:			
MarelliMotori Inspired solutions		DIMENSIONS WITHOUT TOLERANCES PRECISION DEGREE: (TN F 3661)		DIMENSION: mm SCALE: 1:1.25	WEIGHT (kg): n/a
TORSIONAL ANALYSIS DATA MXB 160 - SINGLE BEARING				M16AV001C	A SHEET: 1 OF: 1
This document is the property of Marelli Motori S.p.A. No part of this document may be copied or reproduced in any way. This information is subject to constant review. Measurements on printed drawing are not allowed, any missed dimension or information on the drawing must be pointed out to MarelliMotori.					

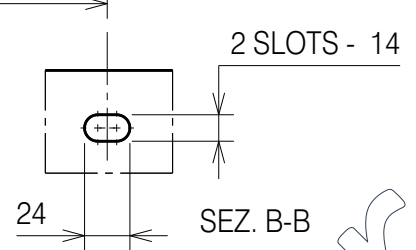
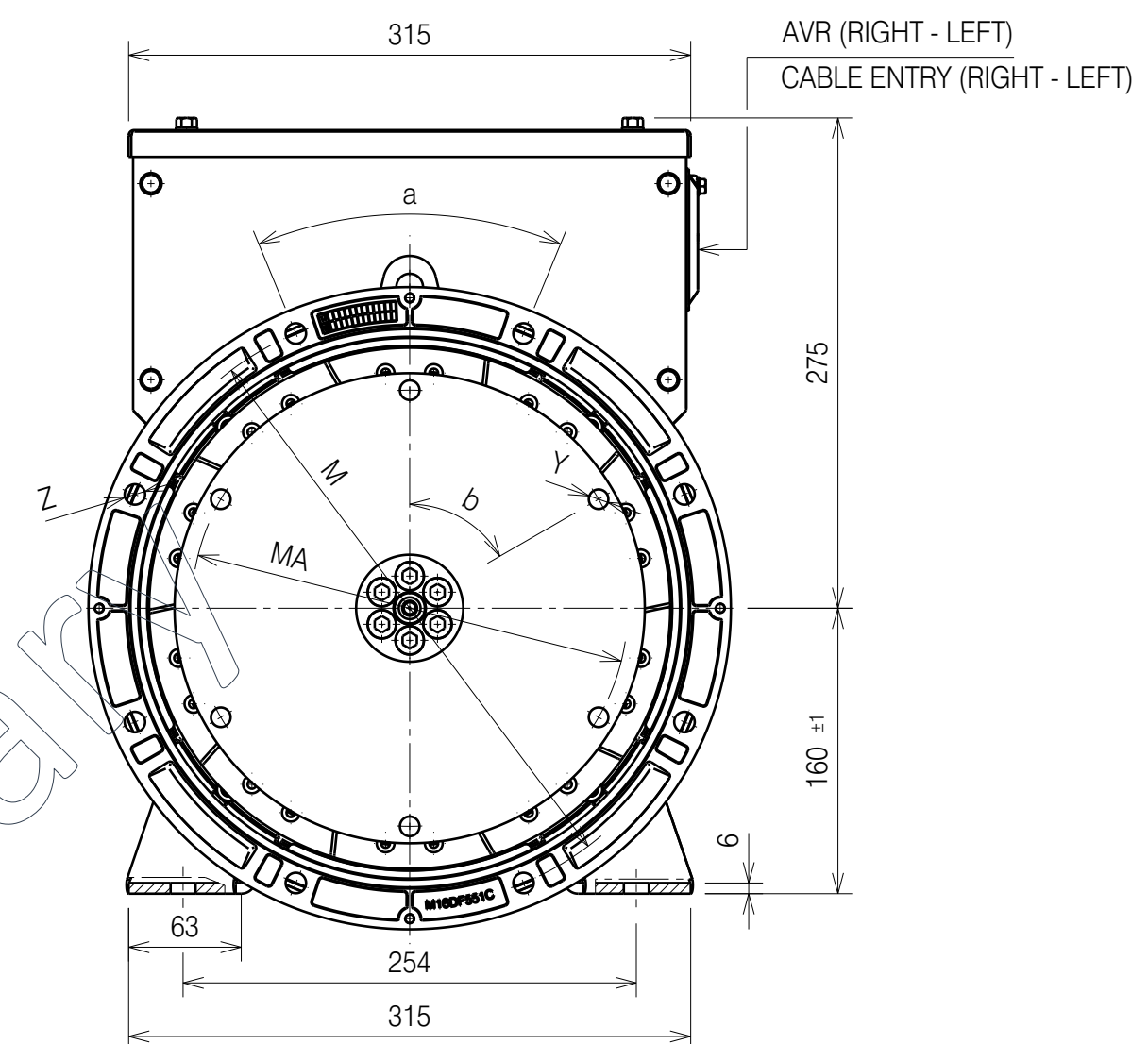
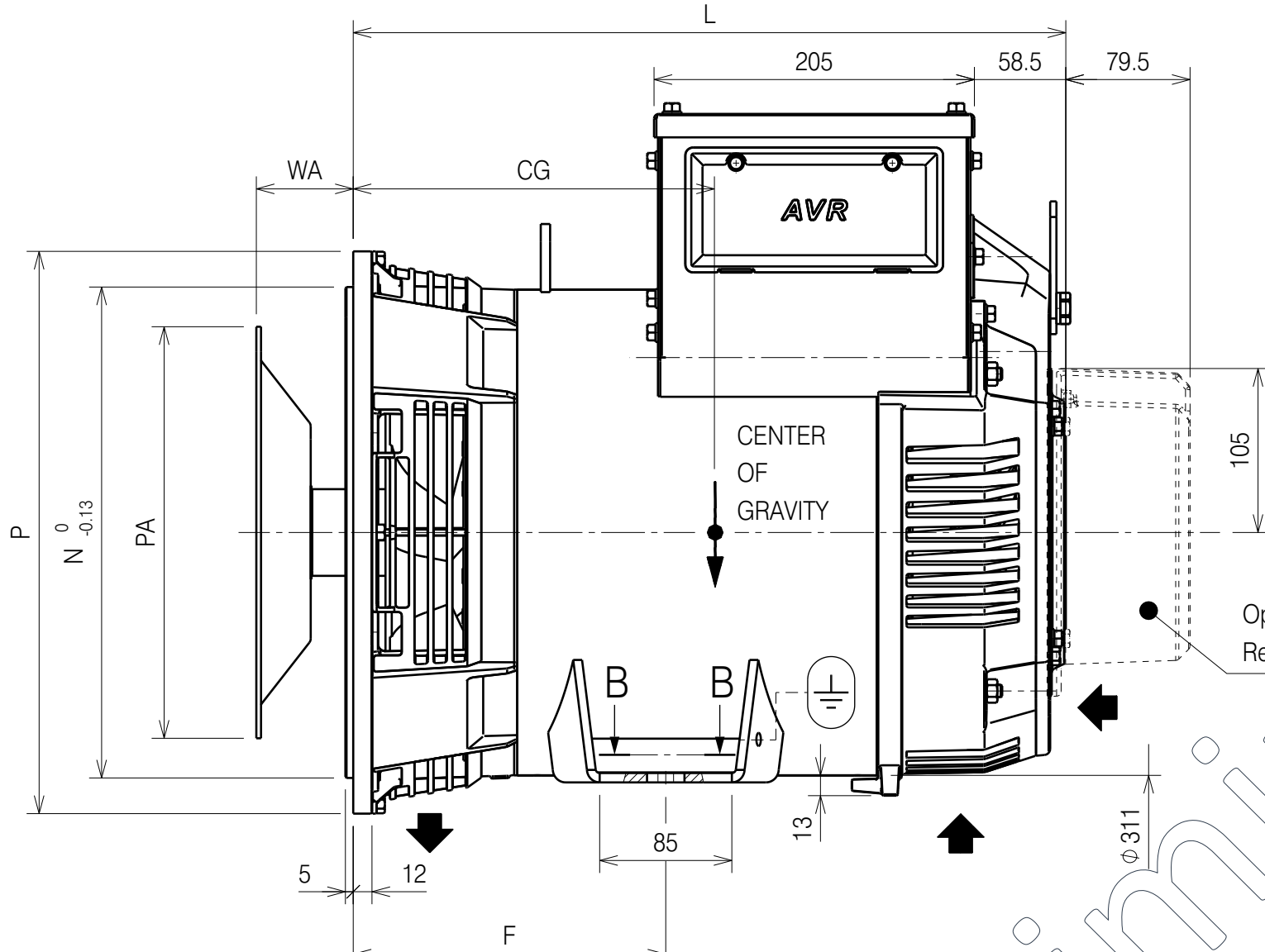

DIMENSIONS													
FLANGE						COUPLING							
SAE J617	N	P	Z NR	φ	a	SAE J620	PA	MA	Y NR	φ	b	WA	WB
5	314.32	360	8	11.5	45°	6 1/2	215.9	200	6	9	60°	30.2	-
4	361.95	407	12	11.5	30°	7 1/2	241.3	222.3	8	9	45°	30.2	-
3	409.58	455	12	11.5	30°	8	263.52	244.48	6	11	60°	62	-
						10	314.3	295.3	8	11	45°	53.8	-
						11 1/2	352.4	333.4	8	11	45°	39.6	-

SUPPORT BEARINGS	PROTECTION DEGREE	TYPE OF CONSTRUCTION IM	DIMENSIONS
ROLLING	IP23	B2	mm

CONNECTINGS			
COUPLING	FLANGE SAE J617		
SAE J620	5	4	3
6 1/2	X		
7 1/2	X	O	
8	X	X	X
10		X	X
11 1/2			X

X AVAILABLE
O MOST COMMON

TYPE	DIMENSIONS		
	L	F	CG SAE 3-4-5
MXB 160 SA	416	200	202
MXB 160 SB			204
MXB 160 MA	441	200	210
MXB 160 MB			212

C	UPDATED DIMENSIONS TABLE (COORD. D1; D2)	D.Pegoraro	I.Graizzaro	F.Savegnago	14/12/2017
B	MODIFIED CG DATA	D.Pegoraro	I.Graizzaro	F.Savegnago	16/10/2017
A	UPDATED TOLERANCE ON HEIGHT 160	D.Pegoraro	I.Graizzaro	F.Savegnago	20/09/2017
REV	DESCRIPTION	PREP'D	CHK'D	APPR'D	DATE
ECO:	HEAT TREATMENT:	MAT:		IND. ENG. CHK'D:	
JOB:	SURFACE TREATMENT:	RAW MAT.CODE:		S.Fanton	
				14/12/2017	
				ATEX APPR'D:	
MarelliMotori Inspired solutions		DIMENSIONS WITHOUT TOLERANCES PRECISION DEGREE: (TN F 3661)		DIMENSION: mm SCALE: 1:4	
		A3		WEIGHT (kg): n/a	
OVERALL DIMENSIONS - MXB 160 B2 SYNCHRONOUS GENERATOR				M16AD021B	
				C Rev	
				SHEET: 1 OF: 1	